



**HAL**  
open science

## Digital Acoustic Projector - A proof of concept

Libor Husnik, Philippe Béquin, Pierrick Lotton, Antonin Novak

► **To cite this version:**

Libor Husnik, Philippe Béquin, Pierrick Lotton, Antonin Novak. Digital Acoustic Projector - A proof of concept. *Applied Acoustics*, 2021, 173, 10.1016/j.apacoust.2020.107667 . hal-03019965

**HAL Id: hal-03019965**

**<https://univ-lemans.hal.science/hal-03019965>**

Submitted on 23 Nov 2020

**HAL** is a multi-disciplinary open access archive for the deposit and dissemination of scientific research documents, whether they are published or not. The documents may come from teaching and research institutions in France or abroad, or from public or private research centers.

L'archive ouverte pluridisciplinaire **HAL**, est destinée au dépôt et à la diffusion de documents scientifiques de niveau recherche, publiés ou non, émanant des établissements d'enseignement et de recherche français ou étrangers, des laboratoires publics ou privés.



# Digital Acoustic Projector - A proof of concept

Libor Husnik<sup>1</sup>, Philippe Béquin<sup>2</sup>, Pierrick Lotton<sup>2\*</sup>, Antonin Novak<sup>2</sup>

<sup>1</sup> Czech Technical University in Prague, Faculty of Electrical Engineering, Technicka 2, 166 27 Praha 6 - Dejvice, Czech Republic

<sup>2</sup>Laboratoire d'Acoustique de l'Université du Mans, LAUM - UMR 6613 CNRS, Le Mans Université, Avenue Olivier Messiaen, 72085 LE MANS CEDEX 9, France

\*[pierrick.lotton@univ-lemans.fr](mailto:pierrick.lotton@univ-lemans.fr)

## Abstract

This paper describes a Digital Acoustic Projector (DAP), which is a hybrid sound system combining both a digital loudspeaker and a parametric array to convert directly an n-bits digital electrical signal into sound. It consists of a set of ultrasonic transducers emitting a sinusoidal signal modulated by a sampled and quantised low-frequency signal. Self demodulation effect is used to demodulate the acoustic signal during its propagation in the air. As a proof of concept, a DAP is designed to convert a 4-bit digital electrical signal into sound. First experimental results are presented.

---

The archived file is not the final published version of the article Husnik, L., Béquin, P., Lotton, P., & Novak, A. Digital acoustic projector—A proof of concept. *Applied Acoustics*, Vol. 173(4), 2021

The definitive publisher-authenticated version is available online at <https://doi.org/10.1016/j.apacoust.2020.107667>, Readers must contact the publisher for reprint or permission to use the material in any form.

---

## 1. Introduction

Digital loudspeaker is defined as an electroacoustic source in which the Digital/Analogue (D/A) conversion is performed either in the mechanical or acoustical part of the system. The use of an electronic D/A converter is no longer necessary and the drawbacks associated to its use are thus avoided. J. L. Flanagan [Flanagan(1980)] was the first to explore the concept of a direct digital to analogue conversion in the 1980s. Since then, many publications have addressed the digital loudspeaker and its application [Huang et al.(2000)Huang, Busbridge, and Fryer], [Morgan and Bolen(1991)], [Furihata et al.(2003)Furihata, Hayama, Asano, and Yanagisawa], [Hayama et al.(2005)Hayama, Furihata, and Zanagisawa], [Husnik(2005)], [Mendoza-Lopez et al.(2006)Mendoza-Lopez, Busbridge, and Fryer], [Cai et al.(2013)Cai, Mu, Wu, and Yang].

The physical principles described in this non-exhaustive list of references are different from those described here and their content is not addressed in this paper. It should be noted that some may use the term digital loudspeaker in a different way, mostly for an assembly of an electrodynamic loudspeaker with an advanced digital signal processing unit. To distinguish between different uses, some use the adverb "true" for the system with the direct digital-to-acoustic conversion, resulting in the term "true digital loudspeaker". A digital loudspeaker composed of an array of individual transducers can be implemented using one of the following arrangements. In a first arrangement, the individual transducers are connected in groups, in which the number of transducers is proportional to the weight of the bit signal feeding it. In a second arrangement, the number of individual transducers corresponds to the number of bits the system uses, and the respective size of their membranes is proportional to the respective bit signal weight. In the particular case of a digital loudspeaker using an electrodynamic transducer, a third arrangement called "multiple voice coil" can be used [Huang et al.(2000)Huang, Busbridge, and Fryer]. Here the voice coil of the electrodynamic transducer is partitioned into sections. The number of voice coil turns in each section is again proportional to the weight of the bit signal it is connected to. The forces acting on the membrane are summed and in this way the D/A conversion is performed in the mechanical part of the system. There are several other ways to embody the digital transducer, including arrangements suited for non conventional electroacoustic transduction principles, e.g. optoacoustic [Lyamshev(2004)]. In this paper, we will concentrate on the first arrangement, i.e. an array of transducers with equal membrane areas.

The aim of this paper is to describe a Digital Acoustic Projector (DAP) [Husnik et al.(2015)Husnik, Béquin, and Lotton], which is a hybrid sound system combining both digital loudspeakers and a parametric array to convert directly a digital electrical signal into sound. The principle and design of this acoustic projector are given in sections 2 and 3. The last section is dedicated to experimental results obtained with a simplified DAP designed to convert 4-bit electrical digital signals into sound.

## 2. Principle of the digital acoustic projector

The principle of a DAP is illustrated in Figure 1. For the sake of clarity and because of limited size of illustrating figures, we will explain the system by its 2-bit version.

The initial analogue electrical signal ① to be converted into sound is first sampled and quantised so that the electrical input signal consists of binary words having a length  $N$  ② ( $N = 2$  in Figure 1). Each bit of this binary word drives a group of ultrasonic transducers ③. When the value of the bit is equal to zero, the associated group of ultrasonic transducers does not emit any signal. On the contrary, when the value of the bit is equal to 1, the associated group of ultrasonic transducers emits a high frequency sinusoidal acoustical signal the frequency of which is denoted  $f_c$ . The duration of this acoustical emission equals the sampling period ④. During the next sampling period, the ultrasonic transducer(s) continue to emit if the bit value is still 1. It / they stop emitting if the bit value is zero, until the bit value changes again to 1.

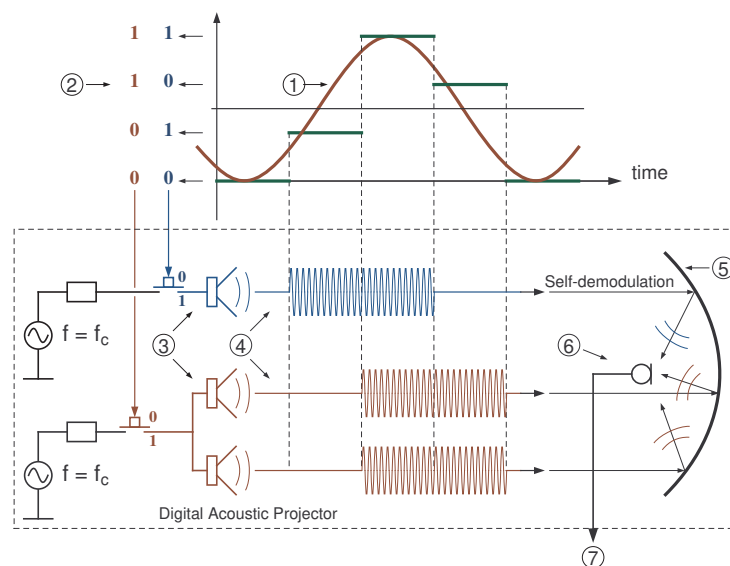

**Figure 1.** Schematic representation of the digital acoustic projector suitable for 2-bit digital signals. ①: Initial analogue signal. ②: Digital conversion. ③: Ultrasonic transducers. ④: On-off modulated sinusoidal signal. ⑤: Parabolic surface. ⑥: Microphone. ⑦: Resulting analogue signal, see Figure 2.

The resulting amplitude of the acoustic signal emitted by the group of transducers driven by the  $n^{\text{th}}$  bit is twice as high as that corresponding to the  $(n-1)^{\text{th}}$  bit. In other words, the amplitude of the signal emitted by each group of transducers follows a  $2^n$  law. Each transducer group faces a parabolic reflector ⑤ so that the different acoustical signals add up in phase at the focal point ⑥ to create the resulting analogue sound pressure signal ⑦.

If the transducers had an impulse response equal to Dirac function, and if there was no distortion during propagation, the resulting sound pressure signal ⑦ measured at the focal point of the parabolic reflector would be proportional to the sum of all electrical signals ④ show in Figure 2(b). In other words, it would be an ultrasonic carrier signal the amplitude of which is modulated by the sampled and quantised low-frequency signal ①. In the signal depicted in Figure 2(b) the content of the low-frequency modulating signal is shifted to high frequencies in both lateral bands at each side of the carrier frequency  $f_c$ , as well-known from amplitude modulation process.

However, none of these assumptions is true. First, the ultrasonic transducers are far from having an impulse response like a Dirac function, second, the amplitude of the sound beam emitted by each source is sufficiently high to cause a distortion of the waveform during its propagation. This distortion is responsible for the generation of sound the content of which corresponds to the frequency differences between the side band components and the carrier frequency. Such a process is the basis for the operation of parametric arrays.

A parametric array is a device allowing the production of acoustic waves based on the principle of nonlinear self-demodulation. It is composed of several ultrasonic transducers, generally arranged in an array on the same plane. These transducers generate a signal composed of an ultrasonic carrier (a simple sinusoid at a frequency higher than 20 kHz) modulated in amplitude by a low-frequency signal, corresponding to the audio signal to be reproduced. The spectrum of an ultrasonic signal of frequency  $f_c$  modulated by a low-frequency signal  $f_m$  shows three components; one component at the frequency  $f_c$  of the carrier and two side components. The two side components are on either side of the carrier, corresponding to the frequencies  $f_c + f_m$  and  $f_c - f_m$ . This inaudible ultrasonic signal is produced at a high level and undergoes nonlinear effects during its propaga-

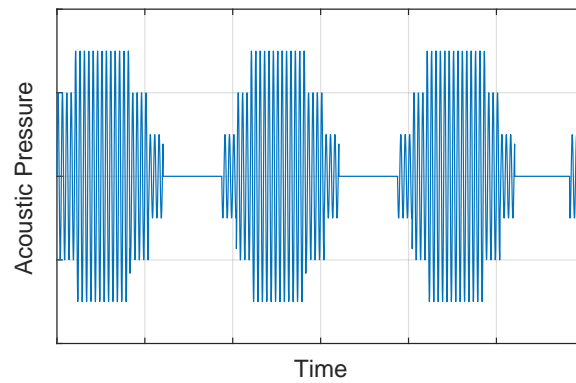

(a) sum of all electrical signals

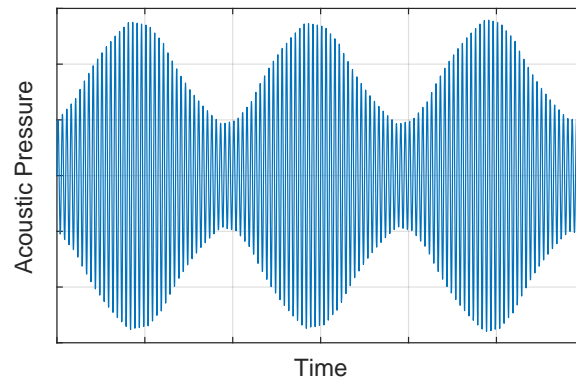

(b) resulting analogue signal (point ⑦ in Figure 1)

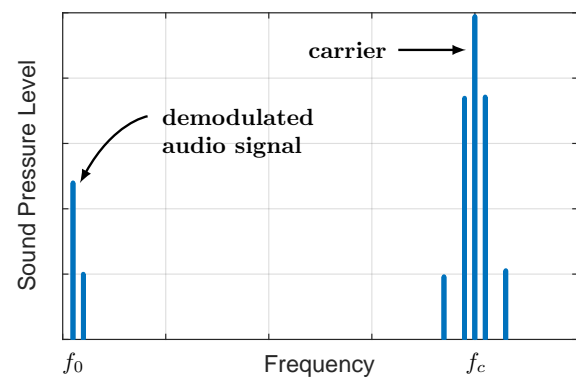

(b) spectrum of the of the resulting analogue signal (b)

**Figure 2.** Theoretical signals and spectrum: (a) sum of all electrical signals (modulated audio signal), (b) resulting analogue signal representing the signal recorded by the microphone (point ⑦ in Figure 1), (c) spectrum of the latter.

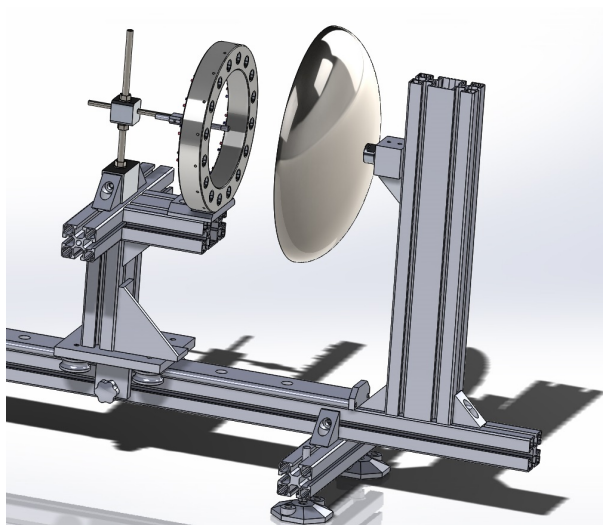

**Figure 3.** Schematic representation of the digital acoustic projector suitable for 4-bit digital signals.

tion, the different components of the signal interact with each other and generate additional components. The majority of these components are at higher frequency than the carrier and are therefore inaudible and rapidly absorbed. However, nonlinear interactions also generate a component whose frequency corresponds to the difference between the frequencies of the components of the initial signal:  $f_c - (f_c - f_m) = (f_c + f_m) - f_c = f_m$ . These interactions allow a transfer of energy to this new component which corresponds to the modulation signal. The envelope of the modulated signal thus becomes audible. More details about parametric arrays can be found in literature, in references [Novikov et al.(1987)Novikov, Rudenko, and Timoshenko, Naugolnykh and Ostrovsky(1998), Hamilton and Blackstock(1999)] or [Yoneyama et al.(1983)Yoneyama, Fujimoto, Kawamo, and Sasabe] for example.

This self demodulation effect is used for DAP to demodulate the amplitude modulated radiated sound wave. Thus, the sampled and quantised low-frequency signal is reconstructed and generated in the audible frequency range.

### 3. Design of the digital acoustic projector

As a proof of concept, a Digital Acoustic Projector is designed to convert a 4-bit digital electrical signal into sound. It is a simplified version of a DAP using only 15 ultrasonic sources divided into four groups. The first group has only one source and is controlled by the least significant bit. The other groups consist of two, four and eight sources respectively and are controlled respectively by the other three bits (the most significant bit driving the group of eight sources).

The experimental setup represented in Figure 3 features three parts; (i) an annular support with the 15 ultrasonic transmitters, (ii) a parabolic reflector, and (iii) an omnidirectional microphone placed at the focal point of the parabolic reflector. Mechanical supports allow precise movement of these three elements relative to each other.

As ultrasonic transmitters, we used commercially available piezoelectric sources (Bestar BPU-1640IOAH12). Figure 4 gives a representative example of the sound level emitted by these ultrasonic transmitters versus frequency. The first resonance frequency is around 40 kHz and the sound level measured at distance  $d \simeq 50$  mm is close to

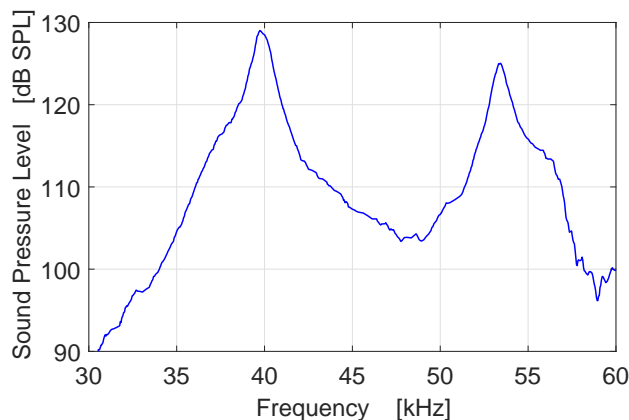

**Figure 4.** Sound pressure level of an ultrasonic emitter measured at distance  $d \simeq 50$  mm for 1 Vrms.

$L_p = 130$  dB for 1 Vrms. This resonance frequency is chosen as carrier frequency. A 308 mm diameter aluminium parabolic reflector with a 76 mm focal length is used to concentrate the sound beams at the focal point. The distance between each transducer and the focal point that the sound waves travel is set to 0.5 m. The acoustic pressure is measured at the focal point with a condenser microphone (GRAS 40BF pressure microphone capsule with Brüel & Kjær 2670 preamplifier). Signal from the microphone is fed to a conditioning amplifier (Brüel & Kjær NEXUS) and acquired with a sound card (Fireface 400 - 24 bit/192 kHz). For this proof of concept, the sequences of the electrical signals at carrier frequency are synthesised by computer for each of the four bits.

#### 4. Experimental results and discussion

As a proof of concept, the DAP is first tested by generating a 1 kHz sound wave. Figure 5 shows the electrical signals applied to each of the four transducer groups to reproduce one period of the sound wave. Each voltage signal is an on/off modulated 40 kHz carrier with a peak amplitude of 10 V. The modulation of each signal is controlled by the value of the corresponding bit.

If the transmitters were wide-band, and if the self-demodulation effect were negligible, the sound pressure signal measured at the focal point of the parabolic reflector would be similar to the 4-bit ( $N = 4$ ) version of Figure 2(a) ( $N = 2$  in Figure 2(a)). However, if the frequency response of the transmitters (Figure 4) is taken into account, the sum of the acoustic signals generated at the output of the transmitters corresponds to the signal given in Figure 6. It can be seen that a filter effect was carried out around the carrier frequency. Thus, no pressure signal is generated in the audible band, especially at the frequency of the modulating signal.

Figure 7 gives the signal measured at the focal point in terms of Sound Pressure Level ( $L_p$ ) as a function of frequency. During the sound wave propagation, the frequency of the initial analogue signal, which is 1 kHz, has been generated by self demodulation effect due to nonlinear interactions of sound waves at 39 kHz, 40 kHz and 41 kHz. The sound level of this audible wave is close to  $L_p = 80$  dB. The transducers all operate at resonance frequency ( $f_c = 40$  kHz) and have been chosen to exhibit the same input resistance  $R_c = 1$  k $\Omega$  at resonance frequency. In addition, each transducer is supplied half time with an electrical sinusoidal signal of peak amplitude  $U = 10$  V (the other half time it is not supplied). Thus, the electrical power supplied to all 15 transducers amounts to  $P = 375$  mW. The efficiency of the system is then 80 dB / 375 mW (or 84 dB/W) at the focal point. Note that the prototype is designed to work only at the focal point. Unwanted harmonic components at 2 kHz and 3 kHz are generated as well due to nonlinear interactions between all the side band components around the carrier frequency.

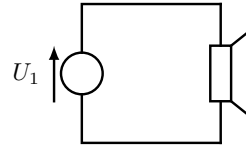

(a) bit 1 (LSB)

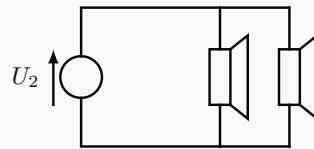

(b) bit 2

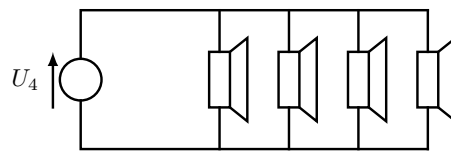
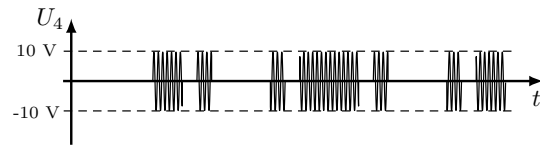

(c) bit 3

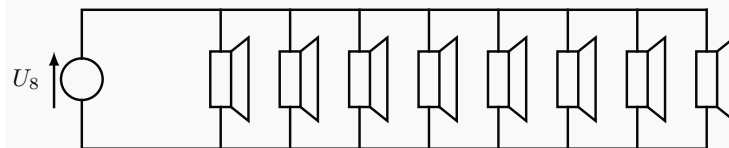
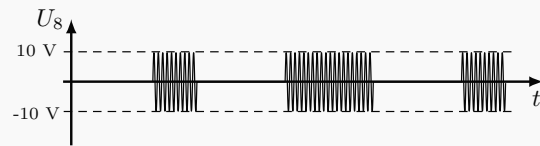

(d) bit 4 (MSB)

Figure 5. Four bit on-off modulated signals feeding associated transducer groups.



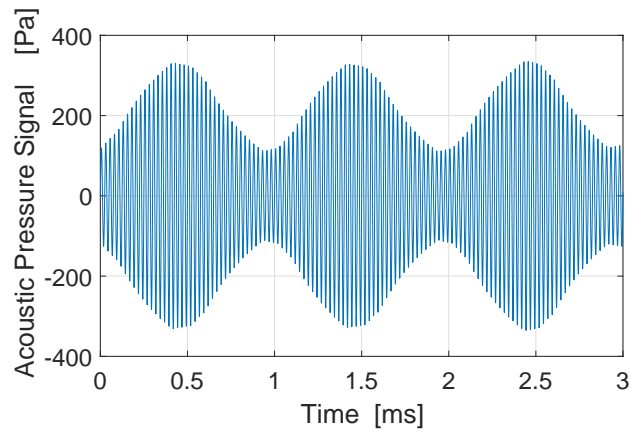

(a)

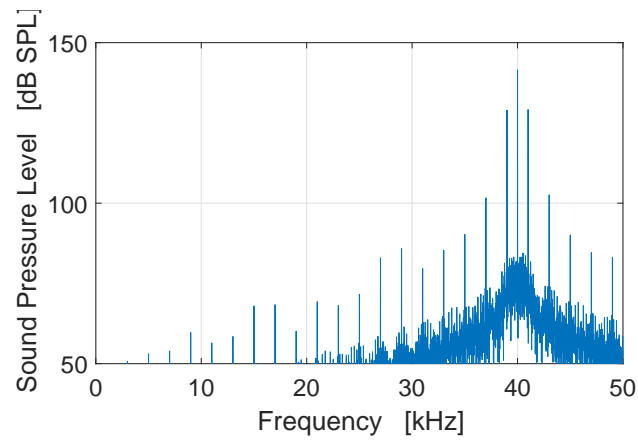

(b)

**Figure 6.** Estimated sum of the acoustical pressure signals generated at the focal point without self-demodulation effect for a 1 kHz, 4-bit digital sinusoidal excitation signal. (a) Temporal signal. (b) Frequency content.

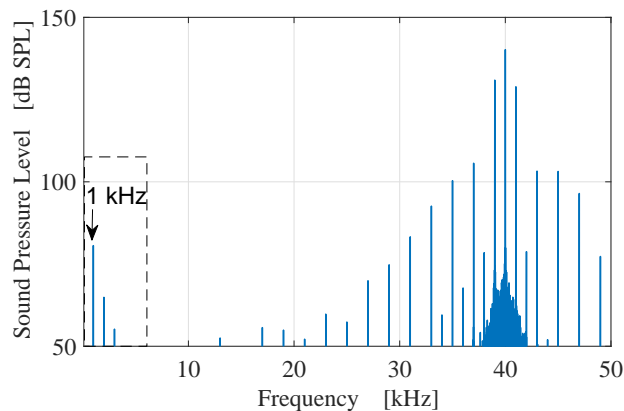

**Figure 7.** Sound pressure level measured with the microphone at focal point for a 1 kHz, 4-bit digital sinusoidal excitation signal.

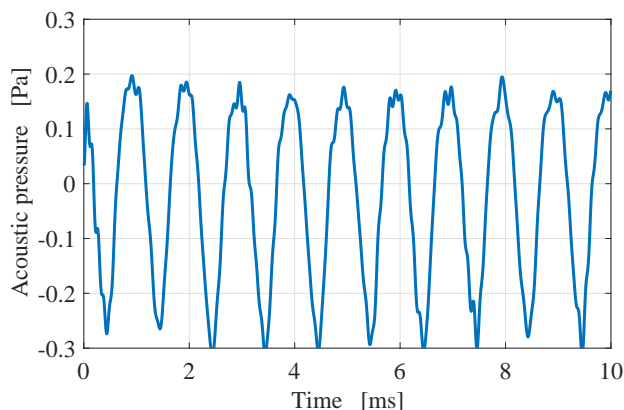
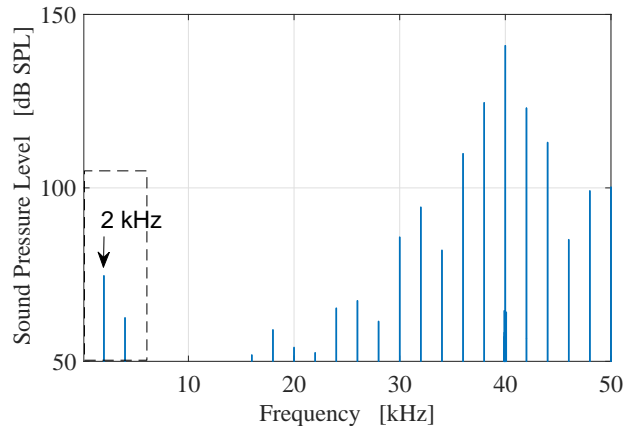

**Figure 8.** Signal obtained after low-pass filtering the signal measured by the microphone at the focal point for 1 kHz, 4-bit digital sinusoidal excitation signal.

Figure 8 shows the audible signal versus time delivered by the DAP to the focal point. This temporal signal was obtained by applying a low-pass filter to the microphone signal (see the dashed box in Figure 7).

Similar results are obtained for a sinusoidal signal of different frequency. As an example, the sound pressure level obtained for a sinusoidal signal with a frequency of 2 kHz is given in Figure 9. The sound pressure level at 2 kHz is approximately  $L_p = 75$  dB. Figure 10 gives the audible signal at the focal point which was obtained by applying a low-pass filter to the microphone signal (see the dashed box in Figure 9). Figures 8, and 10 illustrating measurement results clearly show the reconstructed signals with the fundamental frequency of 1 kHz and 2 kHz respectively. The additional distortion is inherent to the fact that we use only low bit quantisation and that the frequency response of each transducer exhibits a sharp resonance in the frequency range in which we are using them. In addition, unpredictable beam paths can be caused by unwanted reflections, which can also affect the quality of the signal reproduced at low frequencies.

The performance of the system can be improved by using both a higher number of bits, and transducers having a more flat frequency response in the frequency range of interest.



**Figure 9.** Sound pressure level measured with the microphone at the focal point. A 4-bit digital sinusoidal signal with a frequency of 2 Hz is applied to the DAP.

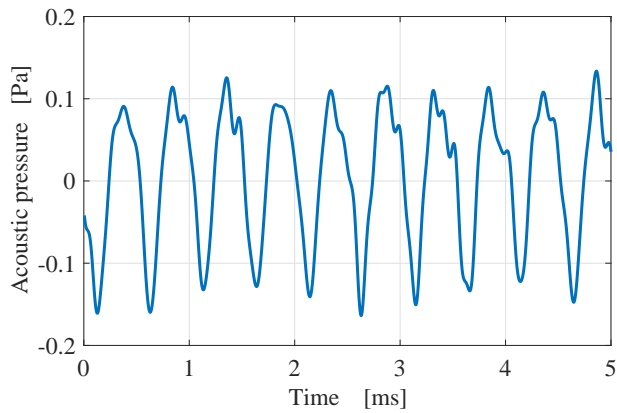

**Figure 10.** Signal obtained after low-pass filtering of the microphone signal measured at the focal point. A 4-bit digital sinusoidal signal with a frequency of 2 kHz is applied to the DAP.

## 5. Conclusion

A new type of digital acoustic projector has been developed. It is a hybrid sound system that combines the principles of both a digital loudspeaker and a parametric array. Digital-to-analogue conversion is performed in the air, not in an electronic D/A converter, by summing ultrasonic acoustic waves, which are modulated by rectangular signals representing respective bit signals from the digital representation of an audio signal. The system uses the effect of self-demodulation in the air along with the summation of all waves in the focal point in order to generate the low frequency audio signal. The first experimental results demonstrate that this new sound system is an alternative to the conventional digital loudspeaker. Some possibilities for improvements are under study. For example, the selected piezoelectric sources exhibit nonlinear behaviour with high signal levels and more linear sources have to be tested. Besides, an electrical signal encoded on a higher number of bits should be used to improve the quality of the sound signal. This implies the use of a higher number of elementary sources. As mentioned earlier, the current version of the system described in this paper allows the initial audio signal to be reconstructed only at the focal point. Future research will also focus on improving the system using waveguide elements.

### Acknowledgments

The authors would like to thank Hervé Mézière for his technical advice and a critical reading of the manuscript by Oliver Munroe.

## References

- [Flanagan(1980)] J. L. Flanagan, Direct digital-to-analog conversion of acoustic signals, *The Bell System Technical Journal* 59 (1980) 1693–1718.
- [Huang et al.(2000)Huang, Busbridge, and Fryer] Y. Huang, S. C. Busbridge, P. A. Fryer, Interactions in a multiple-voice-coil digital loudspeaker, *J. Audio Eng. Soc.* 48 (2000) 545–552.
- [Morgan and Bolen(1991)] M. S. Morgan, L. N. Bolen, Direct digital-to-analog conversion of acoustic signals using a solid dielectric transducer/filter system, *J. Acoust. Soc. Am.* 90 (1991) 2901–2908.
- [Furihata et al.(2003)Furihata, Hayama, Asano, and Yanagisawa] K. Furihata, A. Hayama, D. K. Asano, T. Yanagisawa, Acoustic characteristics of an electrodynamic planar digital loudspeaker, *J. Acoust. Soc. Am.* 114 (2003) 174–193.
- [Hayama et al.(2005)Hayama, Furihata, and Zanagisawa] A. Hayama, K. Furihata, T. Zanagisawa, Acoustic characteristic of an electrodynamic planar digital loudspeaker using noise shaping technology, *J. Acoust. Soc. Am.* 117 (2005) 3636–3644.
- [Husnik(2005)] L. Husnik, Influence of transfer functions of transducers constituting the loudspeaker with the direct d/a conversion on the performance of the system, in: *Proceedings of 118<sup>th</sup> Convention of Audio Engineering Society*, 2005, p. 6519.
- [Mendoza-Lopez et al.(2006)Mendoza-Lopez, Busbridge, and Fryer] J. Mendoza-Lopez, S. C. Busbridge, P. A. Fryer, Sound field characterisation in audio reproduction with the bit-grouped digital transducer array, in: *Proceedings of 120<sup>th</sup> Convention of Audio Engineering Society*, 2006, p. 6836.
- [Cai et al.(2013)Cai, Mu, Wu, and Yang] Y. Cai, Y. Mu, M. Wu, J. Yang, Spatial distribution of signals emitted by a sigma-delta modulation-driven linear digital transducer array, *J. Audio Eng. Soc.* 61 (2013) 99–112.
- [Lyamshev(2004)] L. M. Lyamshev, *Radiation acoustics*, CRC Press, New York, 2004.
- [Husnik et al.(2015)Husnik, Béquin, and Lotton] L. Husnik, P. Béquin, P. Lotton, *Digital loudspeaker*, 2015. Patent US 2018/0160203.
- [Novikov et al.(1987)Novikov, Rudenko, and Timoshenko] B. K. Novikov, O. V. Rudenko, V. I. Timoshenko, *Non-linear underwater acoustics*, American Institute of Physics, New York, 1987.
- [Naugolnykh and Ostrovsky(1998)] K. Naugolnykh, L. Ostrovsky, *Nonlinear wave processes in acoustics*, Cambridge University Press, Cambridge, 1998.
- [Hamilton and Blackstock(1999)] M. F. Hamilton, D. T. Blackstock, *Nonlinear acoustics*, Academic Press, San Diego, 1999.
- [Yoneyama et al.(1983)Yoneyama, Fujimoto, Kawamo, and Sasabe] M. Yoneyama, J.-I. Fujimoto, Y. Kawamo, S. Sasabe, The audio spotlight : an application of nonlinear interaction of sound waves to a new type of loudspeaker design, *J. Acoust. Soc. Am.* 37 (1983) 1532–1536.